

3120-F321-P7T1-W12FY4-0.3A

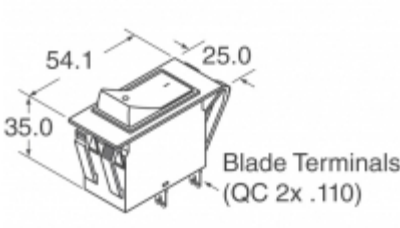

Obrázky jsou pouze orientační.
Podrobné informace o produktu naleznete v části Technické údaje produktu.
Koupit 3120-F321-P7T1-W12FY4-0.3A s důvěrou od Component-World.HK, 1 rok záruka



Part Number: [3120-F321-P7T1-W12FY4-0.3A](#)
Výrobce: [E-T-A](#)
Popis: CIR BRKR THRM 300MA 250VAC 50VDC
Datový list: [3120-F Series Datasheet](#)

RoHS Status: Bez olova / V souladu RoHS
Ship From: Hong Kong
Shipment Way: DHL/Fedex/TNT/UPS/EMS

[Request For Quotation](#)











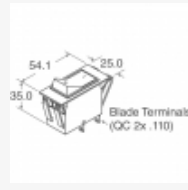

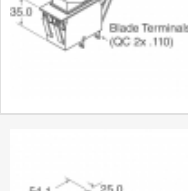
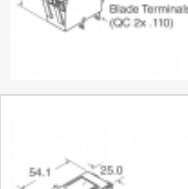
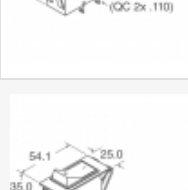

PARAMETR PRODUKTU

Part Number	3120-F321-P7T1-W12FY4-0.3A	Výrobce	E-T-A
Popis	CIR BRKR THRM 300MA 250VAC 50VDC	Stav volného vedení / RoHS	Bez olova / V souladu RoHS
Dostupné množství	2243 pcs	Datový list	3120-F Series Datasheet
Kategorie	Ochrana obvodu	Napítí - DC	50V
Napítí - AC	250V	Série	3120-F
Počet pólů	2	Typ montáže	Panel Mount
Úroveň citlivosti na vlhkost (MSL)	1 (Unlimited)	Výrobní standardní doba výroby	9 Weeks
Stav volného vedení / RoHS	Lead free / RoHS Compliant	Osvětlení napětí (nominální)	-
Osvětlení	-	Jmenovitá hodnota proudu	300mA
Breaker Typ	Thermal	Pohon Type	Rocker

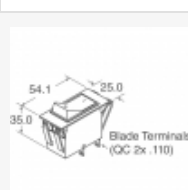
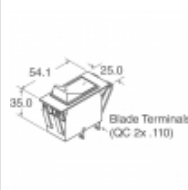
Component-World.com je spolehlivý distributor elektronických součástek. Specializujeme se na všechny elektronické komponenty řady E-T-A. Máme 2243 kusy E-T-A 3120-F321-P7T1-W12FY4-0.3A na skladě dostupných. Vyžádejte si citát z distributora součástí elektroniky na Component-World.com, náš prodejní tým vás bude kontaktovat do 24 hodin.

RFQ Email: info@Components-World.com

SOUVISEJÍCÍ PRODUKTY

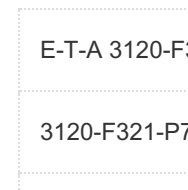
	Část#: 3120-F321-P7T1-W12DY4-8A Popis: CIRC BRKR THRM	Výrobci: E-T-A	Dotaz
	Část#: 3120-F321-P7T1-W12FY3-5A Popis: CIR BRKR THRM 5A 250VAC 50VDC	Výrobci: E-T-A	Dotaz
	Část#: 3120-F321-P7T1-W12FY3-3A Popis: CIR BRKR THRM 3A 250VAC 50VDC	Výrobci: E-T-A	Dotaz
	Část#: 3120-F321-P7T1-W12LY4-4A Popis: CIR BRKR THRM 4A 250VAC 50VDC	Výrobci: E-T-A	Dotaz
	Část#: 3120-F321-P7T1-W12FY3-20A Popis: CIR BRKR THRM 20A 250VAC 50VDC	Výrobci: E-T-A	Dotaz
	Část#: 3120-F321-P7T1-W12FY4-10A Popis: CIR BRKR THRM 10A 250VAC 50VDC	Výrobci: E-T-A	Dotaz
	Část#: 3120-F321-P7T1-W12HY4-2.5A Popis: CIR BRKR THRM 2.5A 250VAC 50VDC	Výrobci: E-T-A	Dotaz
	Část#: 3120-F321-P7T1-W12FY4-8A Popis: CIR BRKR THRM 8A 250VAC 50VDC	Výrobci: E-T-A	Dotaz
	Část#: 3120-F321-P7T1-W12FY3-10A Popis: CIR BRKR THRM 10A 250VAC 50VDC	Výrobci: E-T-A	Dotaz
	Část#: 3120-F321-P7T1-W12GY3-15A Popis: CIR BRKR THRM 15A 250VAC 50VDC	Výrobci: E-T-A	Dotaz
	Část#: 3120-F321-P7T1-W12DY4-5A Popis: CIR BRKR THRM 5A	Výrobci: E-T-A	Dotaz
	Část#: 3120-F321-P7T1-W12LY3-16A Popis: CIR BRKR THRM 16A 250VAC 50VDC	Výrobci: E-T-A	Dotaz
	Část#: 3120-F321-P7T1-W12DY4-3A Popis: CIR BRKR THRM 3A 250VAC 50VDC	Výrobci: E-T-A	Dotaz
	Část#: 3120-F321-P7T1-W12LY4-10A Popis: CIR BRKR THRM 10A 250VAC 50VDC	Výrobci: E-T-A	Dotaz
	Část#: 3120-F321-P7T1-W12DY4-7A Popis: CIR BRKR THRM 7A 250VAC 50VDC	Výrobci: E-T-A	Dotaz
	Část#: 3120-F321-P7T1-W12LY3-3A Popis: CIR BRKR THRM 3A 250VAC 50VDC	Výrobci: E-T-A	Dotaz
	Část#: 3120-F321-P7T1-W12LY4-3A Popis: CIR BRKR THRM 3A 250VAC 50VDC	Výrobci: E-T-A	Dotaz
	Část#: 3120-F321-P7T1-W12FY4-5A Popis: CIR BRKR THRM 5A 250VAC 50VDC	Výrobci: E-T-A	Dotaz
	Část#: 3120-F321-P7T1-W12DY4-4A Popis: CIR BRKR THRM 4A 250VAC 50VDC	Výrobci: E-T-A	Dotaz
	Část#: 3120-F321-P7T1-W12FY3-16A Popis: CIR BRKR THRM 16A 250VAC 50VDC	Výrobci: E-T-A	Dotaz

Související klíčová slova pro 3120-F321-P7T1-W12FY4-0.3A

E-T-A 3120-F321-P7T1-W12FY4-0.3A.	3120-F321-P7T1-W12FY4-0.3A distributor	3120-F321-P7T1-W12FY4-0.3A dodavatel	3120-F321-P7T1-W12FY4-0.3A Cena
3120-F321-P7T1-W12FY4-0.3A Stáhnout datasheet.	3120-F321-P7T1-W12FY4-0.3A Datasheet.	3120-F321-P7T1-W12FY4-0.3A Stock.	koupit 3120-F321-P7T1-W12FY4-0.3A.
E-T-A 3120-F321-P7T1-W12FY4-0.3A.			